

AFLEX™ COMPACT

Specification Sheet

Constant Current Electronic 0-10V Dimmable Programmable LED Driver

The **AFLEX™** Compact platform offers the unparalleled ability to program the driver's power in addition to the output current, dimming curve, dim-to-off functionality, NTC settings – and more; all while maintaining high efficiency over the programmable range. This unique technological advancement enables both ultimate design flexibility and significant SKU elimination. Programming the driver does not require any power and can be done in less than one second. The available auxiliary output provides a power source for sensors and/or cooling devices, eliminating the need for an additional power supply. The **AFLEX™** Compact driver is dimmable down to 0.1% with a 0-10V dimmer. Unequaled flexibility and performance, along with Class P approval and Title 24 compliance, makes the **AFLEX™** Compact driver the perfect choice for commercial lighting fixture application. Title 24 compliance is dependent on dimmer luminaire combination.

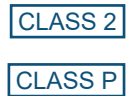

- Installation:** Terminal blocks with side feed or dual (side and back) feed options
- Driver Type:** Class 2 Single Channel
- Dimming:** 0-10V Dimmable Down to 0.1% with Dim-to-Off Capability
- Input Voltage:** Universal 120VAC to 277VAC, 50/60Hz
- Output Voltage:** 3 - 57VDC
- Output Current:** 100 - 1400mA (1mA Step Programmable)
- Environmental:** Dry
- IP Rating:** IP40
- Listing:** UL Listed, Class P, Class 2
- Certifications:** UL8750 | CSA C22.2 No. 250.13-14
- Warranty:** 5-Year

The **AFLEX™** Compact driver is also available in:

- **AFLEX™** Linear
- **JB Series**

Please refer to Magnitudeinc.com for more information.

Ordering Guide

| TYPE | MAX POWER | OUTPUT CURRENT | CASE STYLE | DIMMING CURVE | AUX POWER (OPTIONAL) |
|---------------------|--|-----------------------------|---|--|---|
| AFLEX — AFLEX | 60W (Std) | 1400mA (Std) | S — Side Feed (Std) | L — Linear Curve (Std) | A — 12V PS (Std) |
| AFLEX — AFLEX | 30W — 30W 40W — 40W 50W — 50W 60W — 60W | 100mA — 1400mA (3-57VDC) | S ¹ — Side Feed D — Dual Feed | G — Logarithmic L ¹ — Linear | — — Leave Blank for No Aux Power A ¹ — 12V PS |
| 1 = Default Setting | | | | 1 = Default Setting | |

Driver Dimensions

| | | |
|--------|-------|----------|
| Length | 4.95" | 125.73mm |
| Width | 2.53" | 64.26mm |
| Height | 1.00" | 25.40mm |

Wireless Programmable Features

- ♦ Programmable Power – 30 to 60W
- ♦ Output Current (1mA Step Programmable)
- ♦ Dimming Curve (Linear / Logarithmic)
- ♦ Dim-to-Off (On / Off)
- ♦ NTC Settings



Programming requires Flextool wireless programmer.

SPECIFICATIONS

INPUT

| | |
|---------------------|---|
| Input Voltage Range | Universal 120 - 277VAC ± 10% |
| Input Frequency | 50/60Hz |
| Input Current | 0.29A - 0.6A @ 120VAC 0.15A - 0.25A @ 277VAC* |
| Inrush Current | 38A Max |
| Efficiency | > 88% |
| Power Factor | 0.991 - 0.992 @ 120VAC 0.90 - 0.95 @ 277VAC* (Refer to graph on page 5) |

OUTPUT

| | |
|---------------------------|---|
| Output Voltage Range | 3 - 57VDC |
| Output Current Range | 100 - 1400mA (1mA Step Programmable) |
| Output Current Tolerance | ± 5% |
| Output Current Ripple | ± 5% @ Max load |
| Line Regulation | ± 0.5% |
| Load Regulation | ± 0.5% |
| Turn-On Delay Time | 0.4 sec @ Max load |
| Sensor Power Supply (Aux) | 12V up to 80mA |
| Stand-By Power | > 1W |

ENVIRONMENTAL

| | |
|-------------------------|---|
| Env. Protection Rating | IP40 |
| Surge Protection | 2.5kV |
| Operating Ambient Temp. | -40°C to +60°C |
| Operating Temperature | -40°C to +50°C |
| Storage Temperature | -40°C to +85°C |
| Expected Lifetime | 50k hours at 75°C (Refer to graph on page 7) |
| Audible Noise | < 24dB Class A |
| Withstanding Voltage | 2.5kV |

DIMMING

| | |
|---------------------|--|
| Dimming Control | 0 - 10V |
| Dimming Input Range | -2 to +15V |
| Dimming Curves | Linear / Logarithmic (Programmable) |
| Min. Dimming Level | Dim down to 0.1% |
| Dim-to-Off | Yes (Programmable) |
| Current Consumption | 0.35mA / Source *Depending on Model |

LED THERMAL PROTECTION (NTC)

| | |
|----------------------------|-------------------------------------|
| NTC Value | 15 kQ ± 5% @ 25oC |
| (Mfg. Manufacture: Vishay) | P/N: NTCS0805E3153JMT |
| Output Level Range | 1mA Step Programmable (0 - 100%) |

PROTECTION

| | |
|--------------------------|--|
| Over Current Protection | Current Limiting |
| Short Circuit Protection | Hiccup Mode |
| Over Voltage Protection | Hiccup Mode |
| Over Temp. Protection | Power Derating (Refer to graph on page 7) |
| Mis-Wiring Protection | Auto Shutdown |

MECHANICAL HOUSING

| | |
|---------------------------|--|
| Length | 4.19" (106.43mm) |
| Mounting Length | 4.94" (125.48mm) |
| Width | 2.59" (65.79mm) |
| Height | 1.00" (25.4mm) |
| Housing Material | Aluminum |
| Housing Color | Blue Anodized |
| Junction Box | No |
| Input Connector Types | Black & White Wago 253, Dual Side 16 - 20AWG strip 3/8" |
| Output Connector Types | Red & Blue Wago 253, Dual Side 16 - 20AWG strip 3/8" |
| Dimming Connector Types | Purple & Gray Wago 253, Dual Side 16 - 20AWG strip 3/8" |
| Auxiliary Connector Types | Yellow & Gray Wago 253, Dual Side 16 - 20AWG strip 3/8" |
| NTC Connector Types | Orange & Orange Wago 253, Dual Side 16 - 20AWG strip 3/8" |
| Mounting | (Side Feed) 2-hole half-flange mounts (Dual Feed) 2 additional stud mounts |

APPROVAL MARKINGS

| | |
|-------------------------------|--------------------------|
| Certificates / Approval Signs | UL 8750 Class 2, Class P |
|-------------------------------|--------------------------|

MECHANICAL DIAGRAMS

DUAL FEED

SIDE FEED

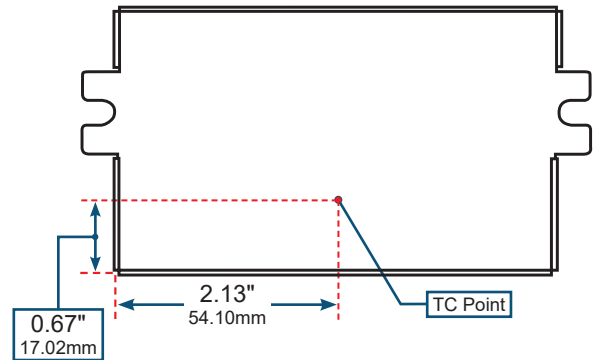
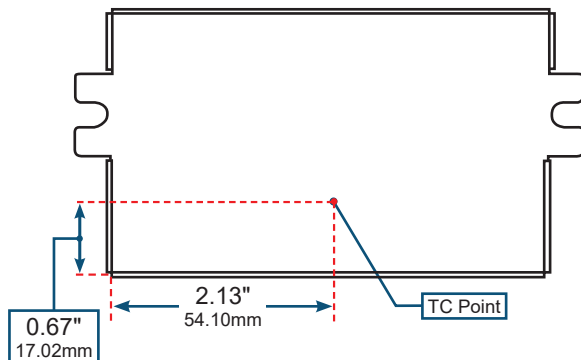
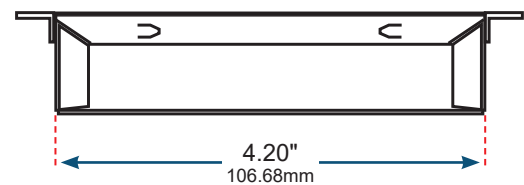
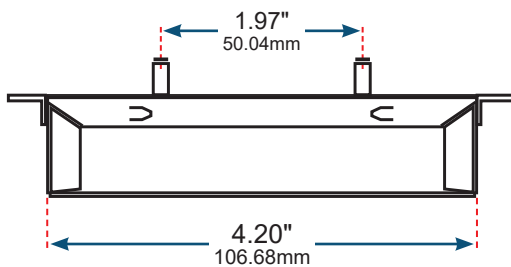
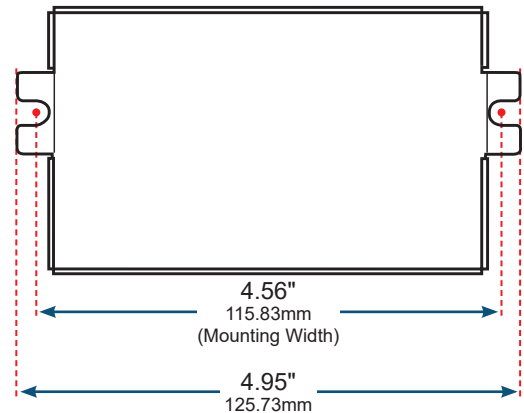
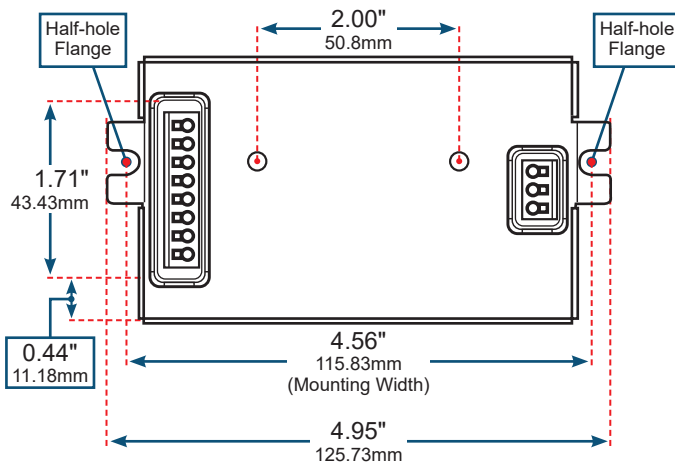

The IEEE P1789 Flicker Test Performance Results

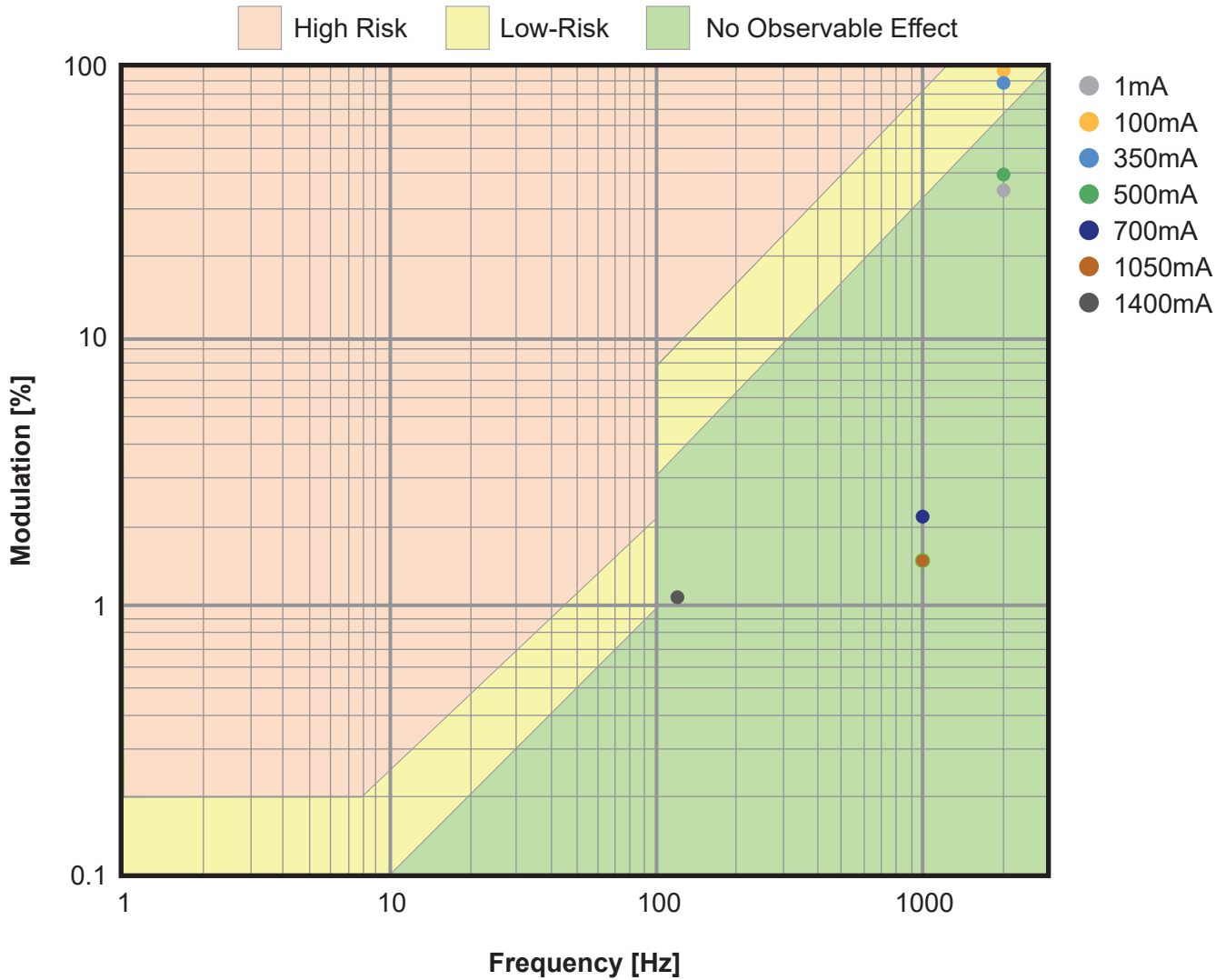

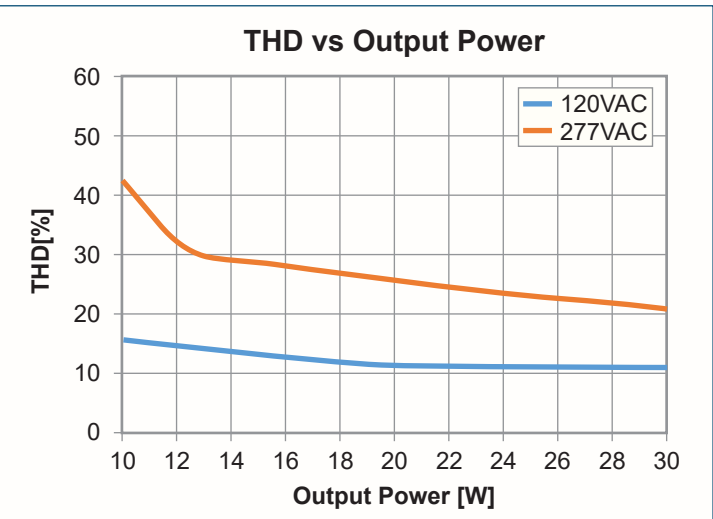
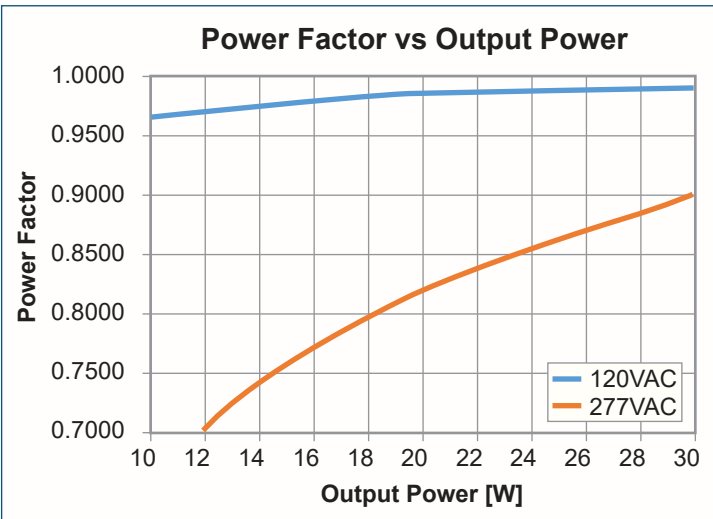
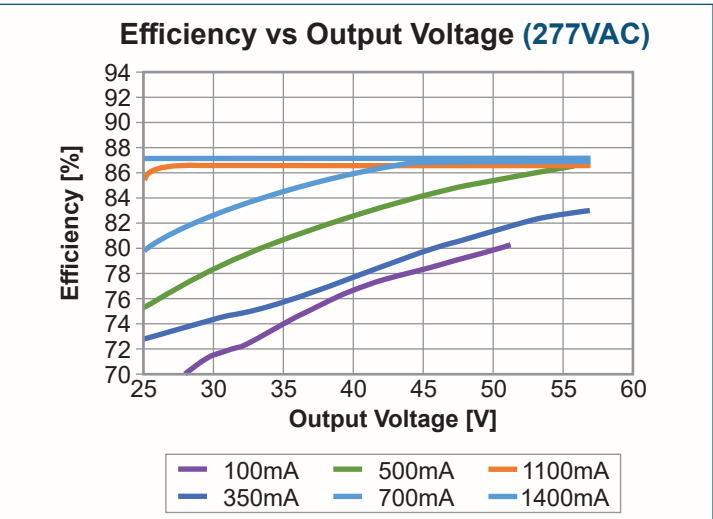
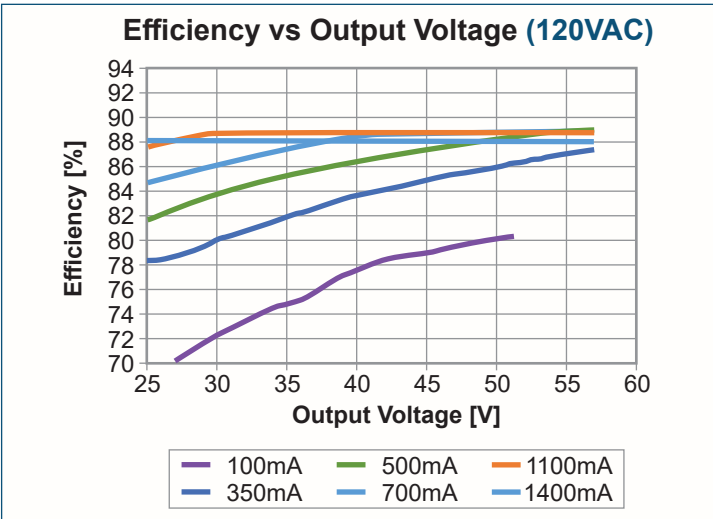
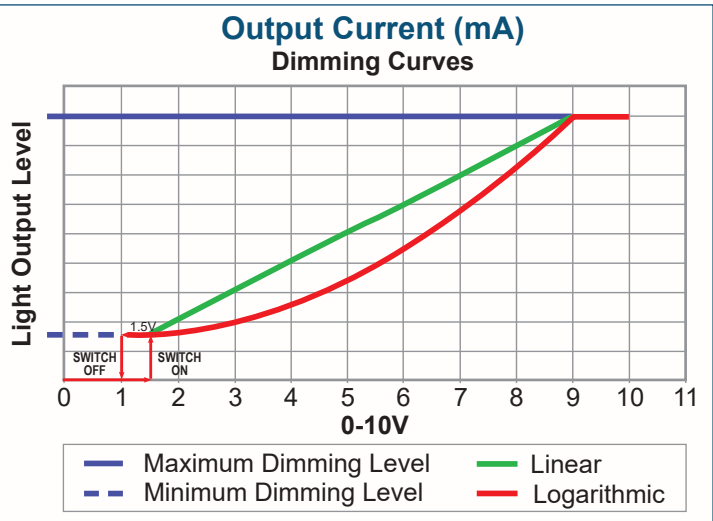
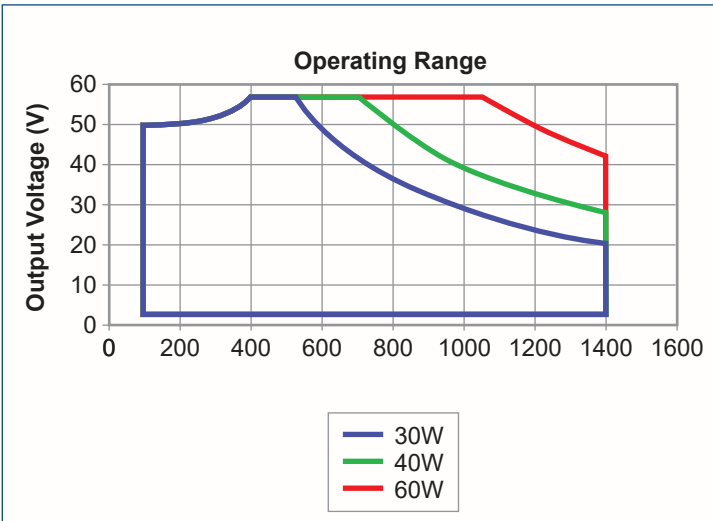

LED Thermal Protection (NTC)

AFLEX™ series drivers help protect the LED's lifetime and will reduce LED temperature by derating the output current in case of high temperatures. The negative temperature coefficient (NTC) thermistor must be connected to the LED driver, as shown in the wiring diagram.

For maximum performance, the NTC thermistor must be placed close to the Tc point of the LED module. The power derating parameters can be programmed using the FlexTool programmer. The NTC outputs can be left disconnected if thermal protection is not required.

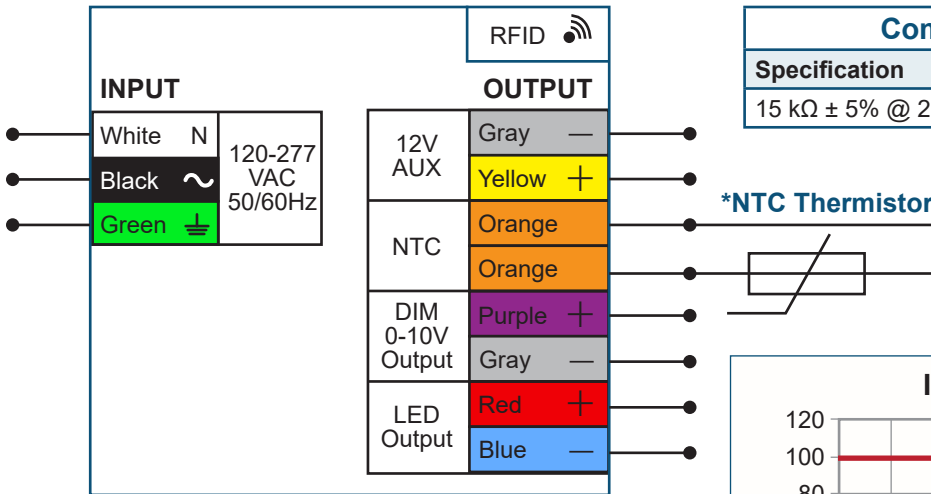

Compatible NTC Thermistor*

| Specification | Manufacturer | Manufacturer P/N |
|-------------------|--------------|------------------|
| 15 kΩ ± 5% @ 25°C | Vishay | NTCS0805E3153JMT |

Ioout (%) vs LED Temperature

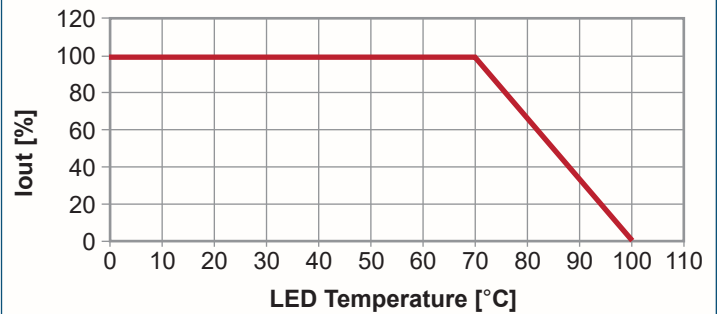

Driver Thermal Protection

Ioout (%) vs Tcase

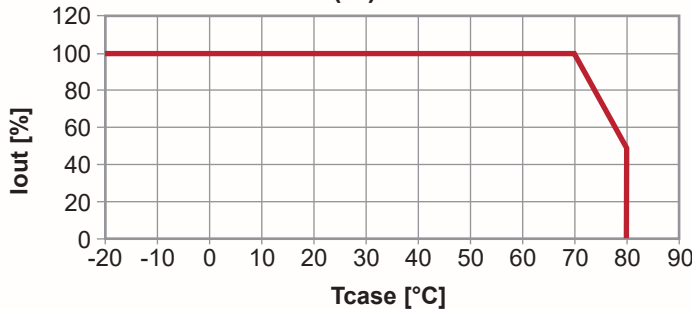

LIFETIME vs Tcase

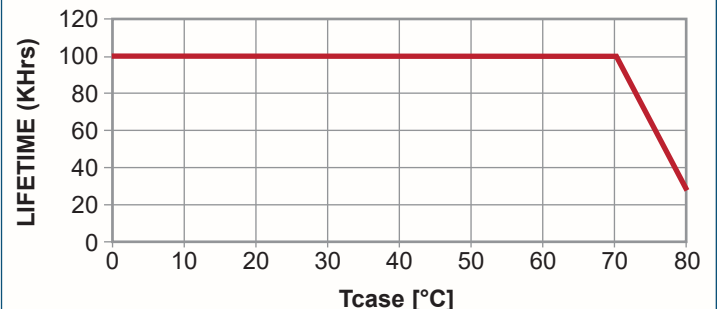

| 5% LED Drop Allowed | | | |
|---------------------|-----------|------------|-------------|
| AWG | 100-700mA | 700-1650mA | 1500-2000mA |
| 18 | 17 ft | 7 ft | 6 ft |
| 16 | 27 ft | 12 ft | 9 ft |
| 14 | 42 ft | 19 ft | 15 ft |
| 12 | 67 ft | 36 ft | 24 ft |

| 10% LED Drop Allowed | | | |
|----------------------|-----------|------------|-------------|
| AWG | 100-700mA | 700-1650mA | 1500-2000mA |
| 18 | 34 ft | 15 ft | 12 ft |
| 16 | 53 ft | 23 ft | 19 ft |
| 14 | 85 ft | 37 ft | 30 ft |
| 12 | 135 ft | 59 ft | 47 ft |

| Temperature Rating | | |
|---|---------|---------|
| Description | Minimum | Maximum |
| Normal Operation | -40°C | +70°C |
| Derating Area | +70°C | +80°C |
| Protection Area | +80°C | |
| Resume Operation After Protection Activated | +70°C | |

| Inrush Current | | |
|----------------|-----------|-----------------|
| VIN (V) | IPEAK (A) | T (@ 50% IPEAK) |
| 120VAC | 14.2 | 1.5 usec |
| 277VAC | 38.0 | 1.2 usec |

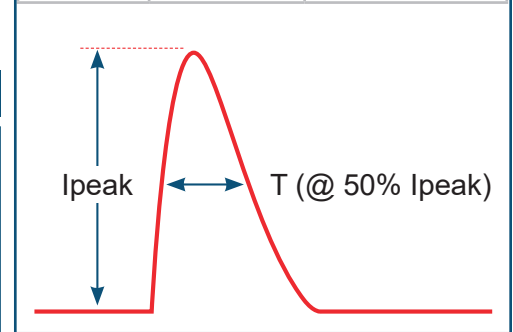

Remote Installation

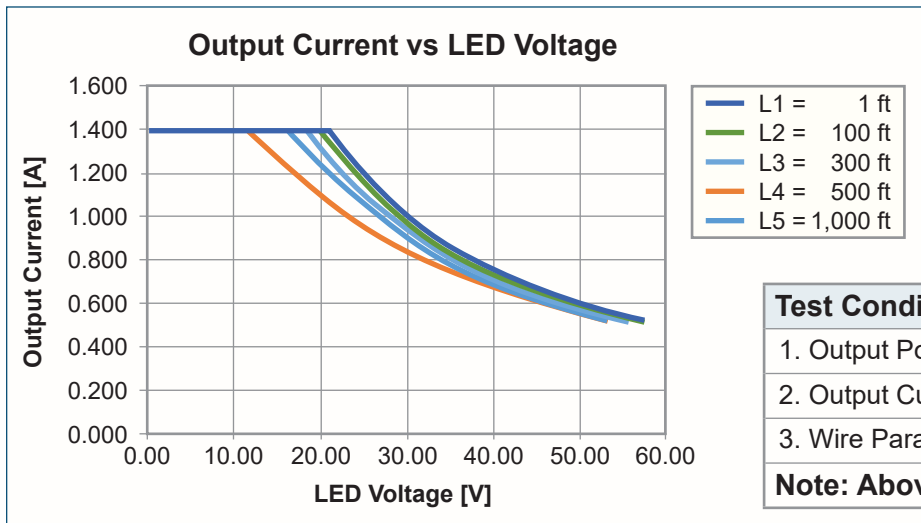

| Test Condition | |
|--------------------|--------------------------------|
| 1. Output Power | = 40W |
| 2. Output Current | = 1.4A |
| 3. Wire Parameters | = 18AWG, 16/30, 6.75Ω / 1,000' |

Note: Above L = 100 ft min / LED voltage = 10V

Compatible 0-10V Dimmers: Please refer to Magnitudeinc.com for compatibility information.

About the FlexTool Wireless Programmer

The FLEXTOOL wireless programmer is used to program Magnitude's Flex Series of LED drivers. By using the FLEXTOOL, OEM's can quickly and smoothly configure the driver's parameters without applying power or wires to the driver.

With the FLEXTOOL software, you can easily save driver configuration profiles externally and use as needed. The software provides graphic and audio indication that the driver was successfully configured.

Please see page 8 for programming information.

Programming the AFLEX™ Compact Driver

Programmable Output Current and Power

Current is programmable in 1mA steps. Power is programmable in 1W steps.

Dimming Control

- Dim-to-Off: Check box (yes/no); Factory Default: Checked (yes)
- Dimming Curve: Logarithmic or Linear; Factory Default: Linear
- Dimmer Type: 0-10(V) or None; Factory Default: 0-10(V)
- Minimum Current (dimming level) before Shut-Off (Dim-to-Off); Factory Default: 1mA

LED Thermal Protection

- Temperature Derating Start; Factory Default: 70°C
- Temperature Derating End; Factory Default: 100°C
- Min. Current before Shut-Off; Factory Default: 1mA

Profile Details

Set parameters and click Save button below

DS Feed **Linear**

Output Power W (it possible to define any power)

Output Current mA

Output Current at MIN Dimmer mA

Dimming Control

Dim to Off

Dimming Curve Logarithmic Linear

Dimmer Type 0-10 None

LED Thermal Protection

Temperature Derating Start °C

Temperature Derating End °C

Min. Current before Shut Off mA

Dimming Curve

| 0-10V Dimmer Level [V] | Output current [mA] |
|------------------------|---------------------|
| 0 | 0 |
| 1 | 155.5 |
| 2 | 311 |
| 3 | 466.5 |
| 4 | 622 |
| 5 | 777.5 |
| 6 | 933 |
| 7 | 1088.5 |
| 8 | 1244 |
| 9 | 1400 |
| 10 | 1400 |

Temperature Graph

| Temperature °C | Output current [mA] |
|----------------|---------------------|
| 0 | 1400 |
| 20 | 1400 |
| 40 | 1400 |
| 60 | 1400 |
| 70 | 1400 |
| 80 | 1000 |
| 90 | 600 |
| 100 | 0 |